



Commercial Hardware

DB430 Series

Deadbolt Locks



MAAX™ IS A TRADEMARK OF MAAX HARDWARE INC.

1-844-666-MAAX | www.maaxhardware.com
Ontario, Canada

- **QUALITY**
- **SECURITY**
- **AETHETICS**

DB430
Deadbolt Locks

TABLE OF CONTENTS

- Overview. 02
- Features and Standards. 03
- DB430- Specifications. 04
- DB430- Functions. 05
- DB430- Finishes. 06
- DB430- How to Order. 06
- DB430- Latches. 07
- DB430- Strikes. 07
- Cylinders, Cores, and Keyways. 08-09

OVERVIEW

QUALITY:

- Conforms to ANSI/BHMA A 156.36 standard, Grade-2
- Heavy duty chassis
- Limited 5 years warranty

SECURITY:

- Offers high security features to discourage abuse and intrusion

AESTHETICS:

- A range of trim finishes to complement different architectural design applications

DB430 Deadbolt Lock

Grade - 2



MAAX DB430 Series Grade-2 heavy duty deadbolt lock provides an outstanding performance at the right price and is the ideal choice for typical commercial and multi-family applications. MAAX DB430 Series deadbolt is highly recommended as a heavy duty alternative to Grade-1 and to complement CL4300/CK4300 Series Grade-2 locksets for an added level of protection against break-in attacks.

FEATURES

- Heavy duty for commercial and multi-family applications
- Hardened steel housing to protect against blunt force attack
- Large steel spin ring to protect against wrench attack
- High-strength deadbolt with hardened steel roller to prevent sawing or cutting
- Concealed mounting screws

STANDARDS

- UL/cUL listed for A label - 3 hours fire rating
- Meets UL 10C positive pressure requirements
- Conforms to ANSI/BHMA A156.36 standard, Grade-2
- Inside thumbturn conforms to the requirements of ANSI A117.1 Accessibility code



CROSS REFERENCE

MAAX	BEST	CORBIN RUSSWIN	DORMA	FALCON	HAGER	SARGENT	SCHLAGE	YALE
DB430	7T	DL2200	DB600	D200	3200	470	B500	D200

Note: Chart prepared by comparing functions of mortise locks based on data obtained from trade sources. It is not guaranteed nor represented that any specific product exactly equals any other product.

SPECIFICATIONS

HANDING:

- Non-handed

DOOR THICKNESS:

- 1-3/8" (35 mm) to 1-3/4" (45 mm) with conventional cylinder - standard
- 2" (51.4 mm) - optional
- 1-5/8" (41 mm) to 2" (51.4 mm) with interchangeable core cylinder - optional

STANDARD DOOR PREP:

- 2-1/8" (54 mm) diameter (bore)
- 1" (25.4 mm) latch hole diameter (cross bore)

BACKSET:

- 2-3/4" (70 mm) - standard
- 2-3/8" (60 mm) - optional
- Adjustable 2-3/8" (60 mm) or 2-3/4" (70 mm) - optional

DEADBOLT:

- 1" (25 mm) throw, brass with saw-resistant hardened steel roller insert - standard

FACEPLATE:

- 1" (25.4 mm) X 2-1/4" (57 mm), square corner - standard
- 1-1/8" (29 mm) X 2-1/4" (57 mm), square corner - optional
- Round corner faceplate - optional

MECHANISM:

- Heavy gauge steel, zinc dichromated for corrosion resistance

CYLINDER AND KEYWAY:

- Conventional 6-pin solid brass, Schlage "C" keyway, keyed different - standard
- Other keying options available from factory
- Small format interchangeable core (SFIC), BEST "F" keyway, keyed different - optional
- Other SFIC keying options including 6 & 7-pin cores and other brands keyways
- SFIC cores ordered separately

KEYS:

- Two brass keys per lock

KEYING:

- Can be master keyed (MK) and grand master keyed (GMK)

STRIKE:

- 1-1/8" (28.2 mm) X 2-3/4" (69.5 mm) X 5/64" (2.0 mm) Rectangular, square corner - standard
- With plastic strike box
- Round corner strike - optional

DB431 Single Cylinder
and Thumbturn

EXPOSED TRIM:

- Stainless steel or brass

FASTENERS:

- No exposed screws

FUNCTIONS:

- See Functions for detailed list





FINISHES:

- US3 (605) Bright brass, clear coated
- US10B (613) Dark satin bronze, clear coated
- US15 (619) Satin Nickel, clear coated
- US26D (626) Satin chromium plated
- US32 (629) Bright stainless steel
- US32D (630) Satin stainless steel
- Other finishes available with longer lead time

WARRANTY:

- Limited 5 years

FUNCTIONS

	Function	Model No.	ANSI	Function Description
	Cylinder X Thumbturn Deadbolt	DB431	E0152	<ul style="list-style-type: none"> ▪ Deadbolt projected and retracted by key outside or thumbturn inside.
	Cylinder X Cylinder Deadbolt	DB432	E0142	<ul style="list-style-type: none"> ▪ Deadbolt projected and retracted by key either side.
	Cylinder X Classroom Deadbolt	DB434	E0172	<ul style="list-style-type: none"> ▪ Deadbolt projected and retracted by key outside. ▪ Thumbturn inside retracts deadbolt but cannot project it.
	Cylinder X Blank plate	DB436	E0162	<ul style="list-style-type: none"> ▪ Deadbolt projected and retracted by key one side. ▪ Blank plate on other side.
	Thumbturn Only, no outside trim	DB438	E0192	<ul style="list-style-type: none"> ▪ Deadbolt projected and retracted by Thumbturn one side. ▪ No trim on other side.

FINISH OPTIONS

Finish Options						
Color	Bright Brass	Oil rubbed Bronze	Satin Nickel	Satin Chrome	Bright Stainless Steel	Satin Stainless Steel
ANSI/BHMA Number	605	613	619	626	629	630
US Number	US3	US10B	US15	US26D	US32	US32D

▪ Other finishes available with longer lead time and minimum order quantity

HOW TO ORDER DB430 DEADBOLTS

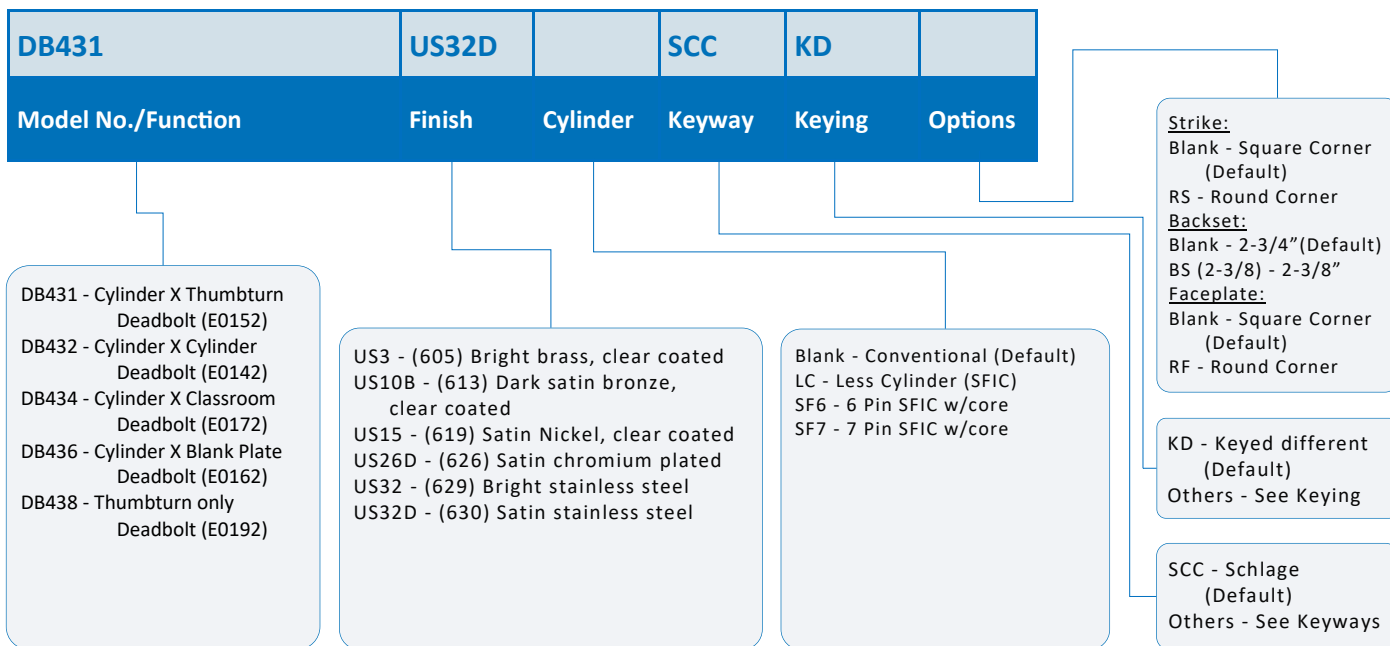

LATCHES

DB430 DEADBOLT LOCK - LATCHES

- Item No. 400211 (2-3/4" - 70 mm) Deadbolt Latch - standard
- Item No. 400212 (2-3/8" - 60 mm) Deadbolt Latch - optional
- Faceplate: 1" (25.4 mm) X 2-1/4" (57 mm) - standard
1-1/8" (29 mm) X 2-1/4" (57 mm) - optional
- Backset: 2-3/4" (70 mm) - standard, 2-3/8" (60 mm) - optional
- Deadbolt Latch: 1" (25.4 mm) Throw

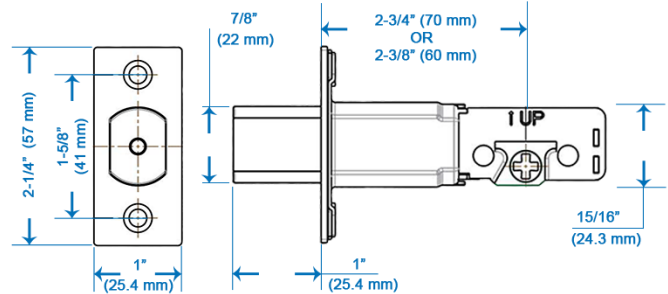
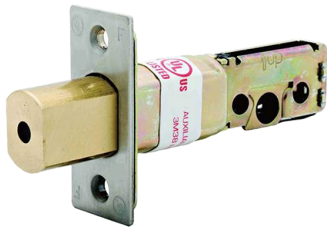

- Item No. 400213 Adjustable (2-3/8" - 60 mm) - (2-3/4" - 70 mm) Deadbolt Latch - optional

- Faceplate: 1" (25.4 mm) X 2-1/4" (57 mm) - standard
1-1/8" (29 mm) X 2-1/4" (57 mm) - optional
- Backset: Adjustable 2-3/8" (60 mm) - 2-3/4" (70 mm)
- Deadbolt Latch: 1" (25.4 mm) Throw

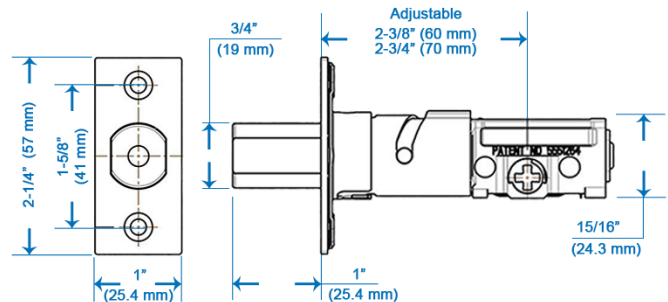

STRIKES

DB430 DEADBOLT LOCK - STRIKES

- Item No. 400511
- Rectangular Strike (Square) - Standard
- Size:
1-1/8" (28.2 mm) X 2-3/4" (69.5 mm)
X 5/64" (2.0 mm)
- With plastic strike box



- Item No. 400512
- Rectangular Strike (Round) - Optional
- Size:
1-1/8" (28.2 mm) X 2-3/4" (69.5 mm)
X 5/64" (2.0 mm)
- With plastic strike box



STANDARD DEADBOLT CYLINDER

FEATURES:

- 6 pin conventional deadbolt cylinder - Standard
- Keyway: Schlage "C" keyway - Standard
- Cylinder length: 1-1/8" (29 mm) or 1-1/4" (32 mm)
- Keying: Keyed different (KD) - Standard
- Tailpiece: Deadbolt tailpiece - Standard
- Keying: Keyed different (KD) - Standard
- Optional: Other keyways and Master keying

MATERIAL:

- Cylinder body: Solid brass
- Cylinder face: Brass



Conventional Cylinder

INTERCHANGEABLE CYLINDER (IC)

FEATURES:

- Interchangeable cylinder (IC) is an optional mortise cylinder offering immediate re-keying by simply using a special "control key" to replace the core without removing the cylinder housing
- "SFIC" Small format interchangeable core:
 - 6 pin, 1-1/4" (32 mm) cylinder length
 - 7 pin, 1-3/8" (35 mm) cylinder length
- Keyway: See Keyways and Keying
- Cores are ordered separately

MATERIAL:

- Cylinder body: Solid brass
- Cylinder face: Brass



SFIC Cylinder w/Core

CYLINDER CORES















Deadbolt Conventional Core



SFIC Core

KEYWAYS

CONVENTIONAL DEADBOLT CYLINDER		
KEYWAY		SUFFIX
SCHLAGE C (Default)		SCC
ARROW AR1		AR1
CORBIN 60		CO60
CORBIN L4		COL4
KWIKSET		KW1
RUSSWIN D1		RUD1
SARGENT LA		SALA
SCHLAGE E		SCE
SCHLAGE F		SCF
WEISER E		WEE
YALE E1R		YAER
YALE GA		YAGA
SMALL FORMAT INTERCHANGEABLE CORE (SFIC)		
KEYWAY		SUFFIX
BEST F 7-pin (Default)		BF7
BEST A, B, C, D, E, G, H, J, K, L, M, Q		BA6, BA7, BB7, BC7, BD7, BE7, BG7, BH7, BJ7, BK7, BL7, BM7, BQ7

KEYING

KEYING ABBREVIATIONS	
KEYWAY	SUFFIX
Keyed Different (Default)	KD
Keyed Alike	KA
"0" Zero Bitted	K0
Master Key	MK
Grand Master Key	GMK
Construction Master Key	CMK
KEYING OPTIONS (CONVENTIONAL)	
<ul style="list-style-type: none"> ▪ Keyed alike and "0" bitted cylinders (6 pin only) ▪ Master keyed: Must specify quantity of master keys ▪ Construction master keyed: Schlage C, E & F ▪ Submit master keying form ▪ Extra cut keys ▪ Key marking ▪ Cylinder marking ▪ Bitting lists (ordered separately) ▪ Check availability of keyways at the time of ordering 	
KEYING OPTIONS (SFIC)	
<ul style="list-style-type: none"> ▪ Cores are keyed different unless otherwise specified ▪ Keyed alike ▪ Construction cores ▪ Master keyed: Must specify quantity of master keys, control keys or additional change keys ▪ Key marking ▪ Core marking ▪ Do not duplicate ▪ Bitting lists (ordered separately) 	



Commercial Hardware

DB430 Series

Deadbolt Locks

MX-DB430-20

© 2020 MAAX HARDWARE INC.

MAAX™ IS A TRADEMARK OF MAAX HARDWARE INC.

1-844-666-MAAX | www.maaxhardware.com
Ontario, Canada